

Female FIN(47KG) / 1st

- (K):KO
- (R):RSC
- (S):Superiority
- (W):Withdrawal
- (D):Disqualification
- (F):Foul
- (S):Sudden Death

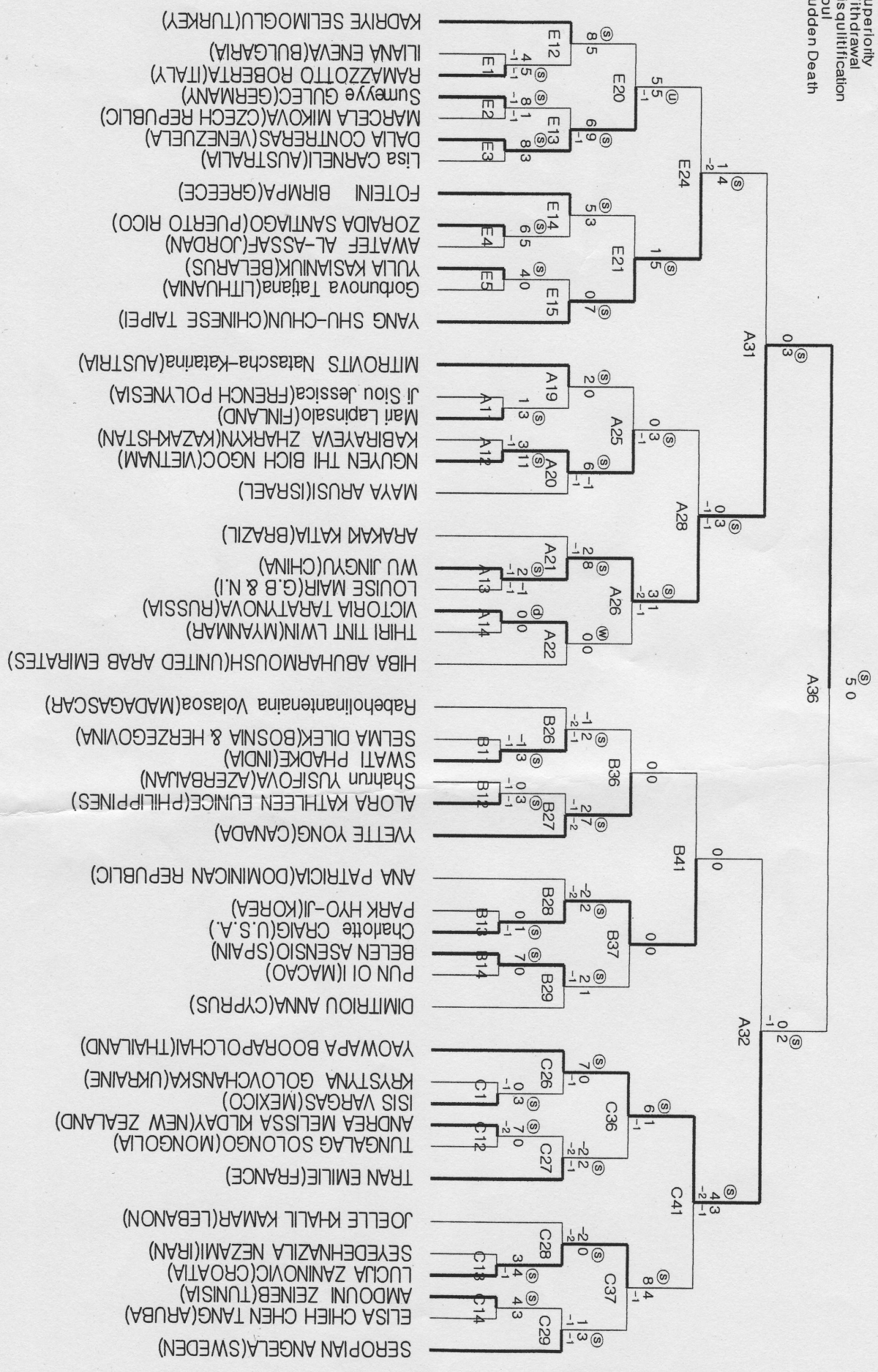

Female FLY(51KG) / 3rd

- (K):KO
- (T):RSC
- (S):Superiority
- (M):Withdrawal
- (D):Disqualification
- (F):Foul
- (SD):Sudden Death

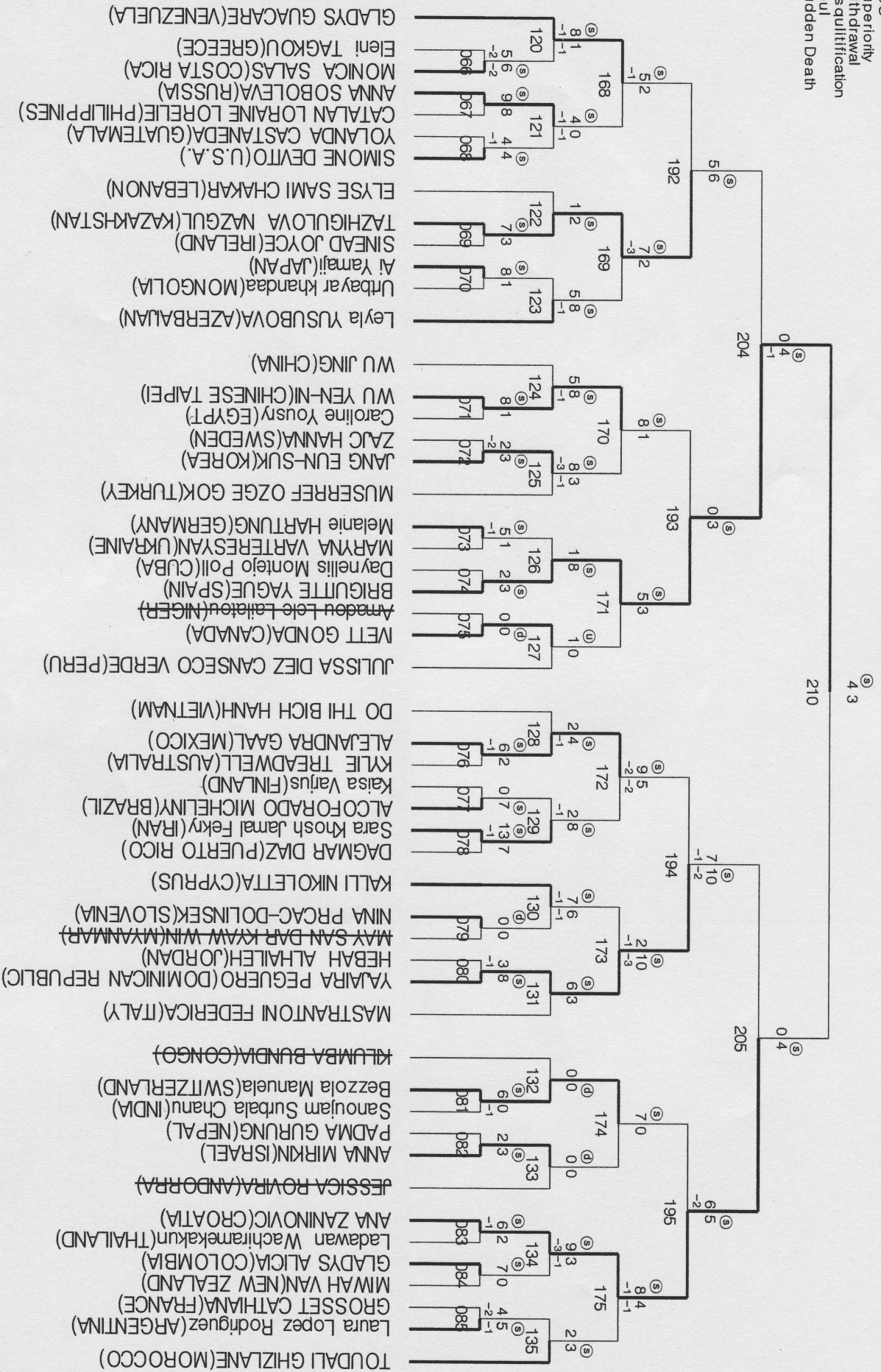

482011

Female BANTAM(55KG) / 1st

- (K):KO
- (T):RSC
- (S):Superiority
- (W):Withdrawal
- (D):Disqualification
- (F):Foul
- (U):Sudden Death

46
-1

A37

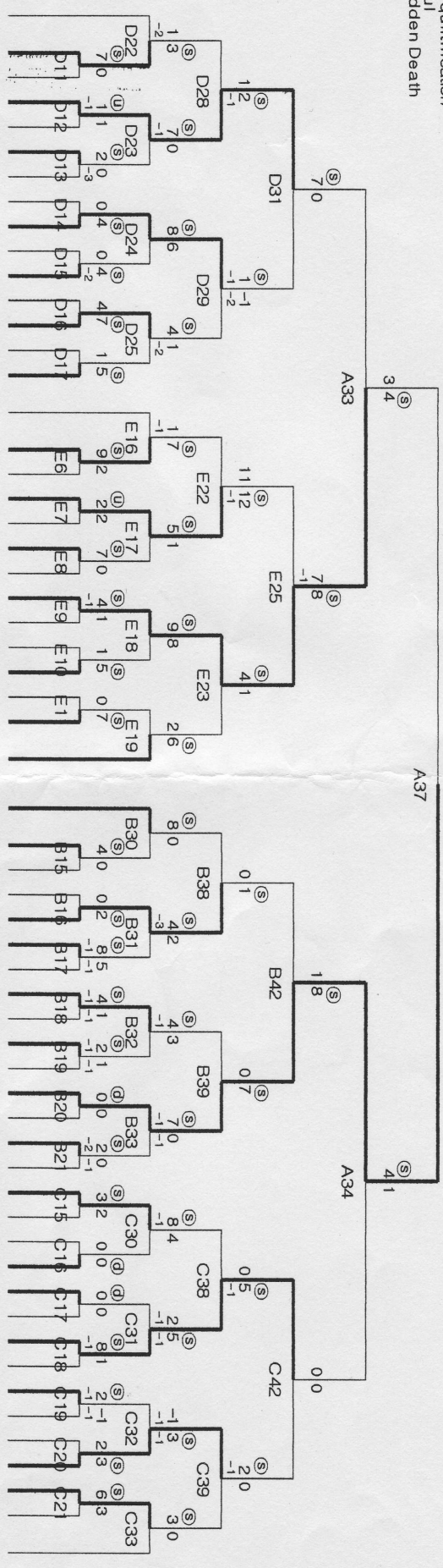

MARISOL PENUELAS(MEXICO)
 EUDA CARIAS(GUATEMALA)
 ELENI KOUTSILIANOS(U.S.A.)
 Kaydashova Ina(UZBEKISTAN)
 MVEANG NZOCHE(GABON)
 JENNIFER BUSKES(SOUTH AFRICA)
 ZAINAB HEIDARY(IRAN)
 SARA RAMOS(PUERTO RICO)
 ANDREA RICA(ESPAIN)
 Abeer Essawy(EGYPT)
 VITTELLO ELVIRA(ITALY)
 Nigar HAJYEVA(AZERBAIJAN)
 SOE SOE MYAR(MYANMAR)
 JULIA KUZMINA(LATVIA)
 Thale Lovass(NORWAY)
 Paragiota MAKRI(GREECE)
 GANNA REZNIK(UKRAINE)
 FRANSISCA VALENTINA(INDONESIA)
 JUNG JIN HEE(KOREA)
 TRUBISINA EKATERINA(TAJIKISTAN)
 YUL'YA SMYCHKOVA(BELARUS)
 Caroline MARTON(AUSTRALIA)
 ZENEPE KIREZ(TURKEY)
 MARTINA ZUBCIC(CROATIA)
 LAKSHMI YUMANKONG(THAILAND)
 COSETTE JOSEPH BASBOUS(LEBANON)
 NelliAh Ahmadee(AFGHANISTAN)
 HADEEL FAWZY(QATAR)
 ASMA IMDAD(PAKISTAN)
 EDINA KOTISIS(HUNGARY)
 Demet OZCAN(GERMANY)
 EZZAKRAOUY NAIMA(MOROCCO)
 SONAM GAKI(BHUTAN)
 ZHANG BIYU(CHINA)
 MONICA F. PIMENTEL(ARUBA)
 HOANG HA GIANG(VIETNAM)
 TSENG YI-HSIUAN(CHINESE TAPEI)
 MELANIE MAURICE(NEW ZEALAND)
 BAT-EL GATTERER(ISRAEL)
 SARDAROVA SAULE(KAZAKHSTAN)
 MARGARITA MKRTCHAN(RUSSIA)
 CAROLINE FISHER(G.B & N.I.)
 SHANNON CONDIE(CANADA)
 AFO Patricia(FRENCH POLYNESIA)
 MILADYS MARINO(VENEZUELA)
 MILEA IONELA(ROMANIA)
 MUSSO MAEVA(FRANCE)
 WEINZIERL Lisa Maria(AUSTRIA)
 SAUDY MIURCA ARIAS RIVERA(DOMINICAN REPUBLIC)
 Mia Stenvall(FINLAND)
 CRUZ PAULA(BRAZIL)
 SEEMA DESWAL(INDIA)
 JENNIFER DUPONT(BELGIUM)
 MAKAVU JULIA(LESOTHO)
 SIMBULAN SABRINA JO(Philippines)
 Yaimara Rosario Ferrer(CUBA)
 Tumorbaatar Delgertsetseg(MONGOLIA)
 Akiko Kotera(JAPAN)
 TANJA TAMACKOVIC(SERBIA)

Female FEATHER(59KG) /2nd

- Ⓚ:KO
- Ⓛ:RSC
- Ⓢ:Superiority
- Ⓜ:Withdrawal
- Ⓝ:Disqualification
- Ⓣ:Foul
- Ⓜ:Sudden Death

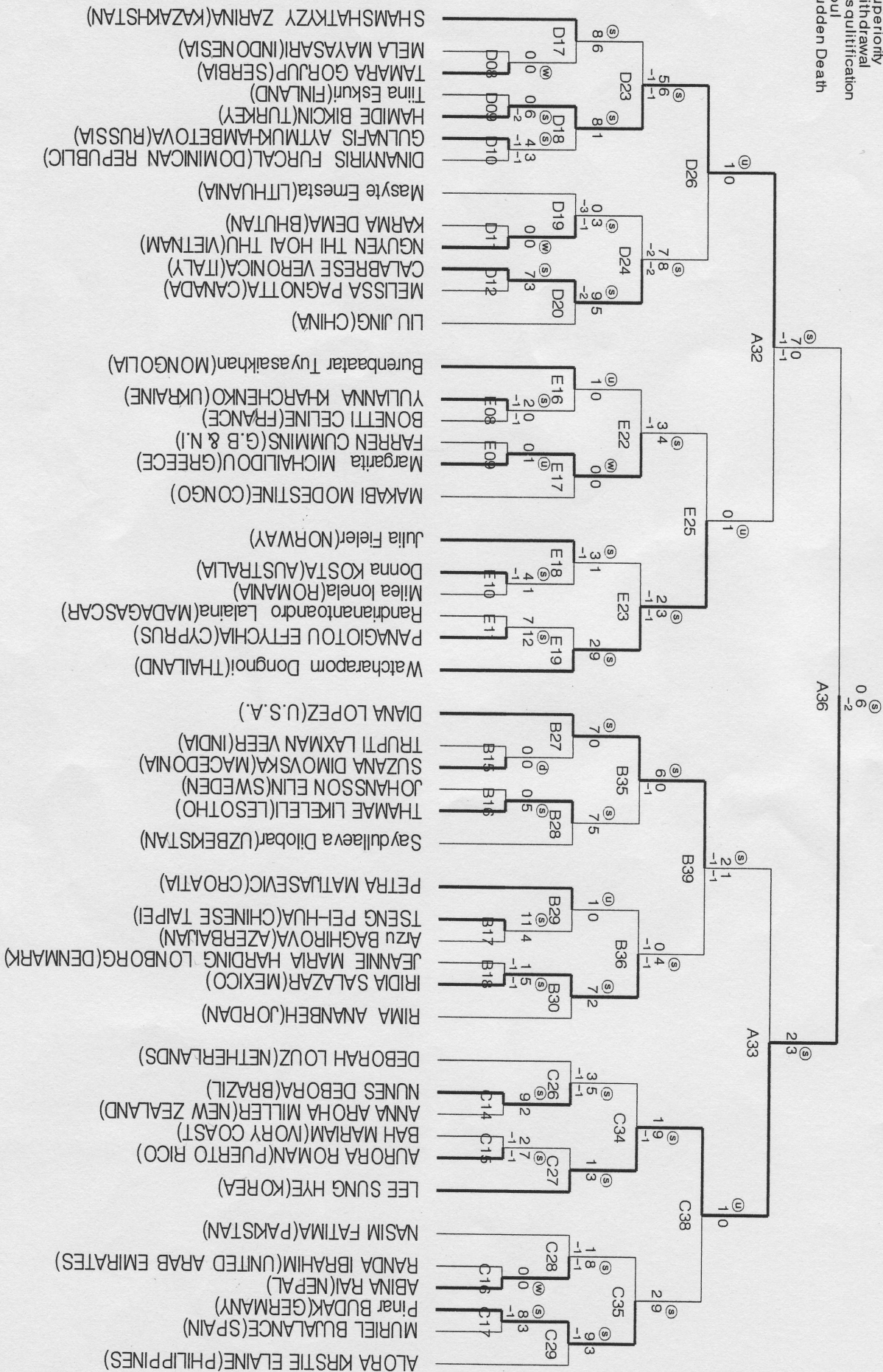

49 2007

Female LIGHT(63KG) / 4th

- Ⓚ:KO
- Ⓛ:RS C
- Ⓢ:Superiority
- Ⓜ:Withdrawal
- Ⓛ:Disqualification
- Ⓣ:Foul
- Ⓢ:Sudden Death

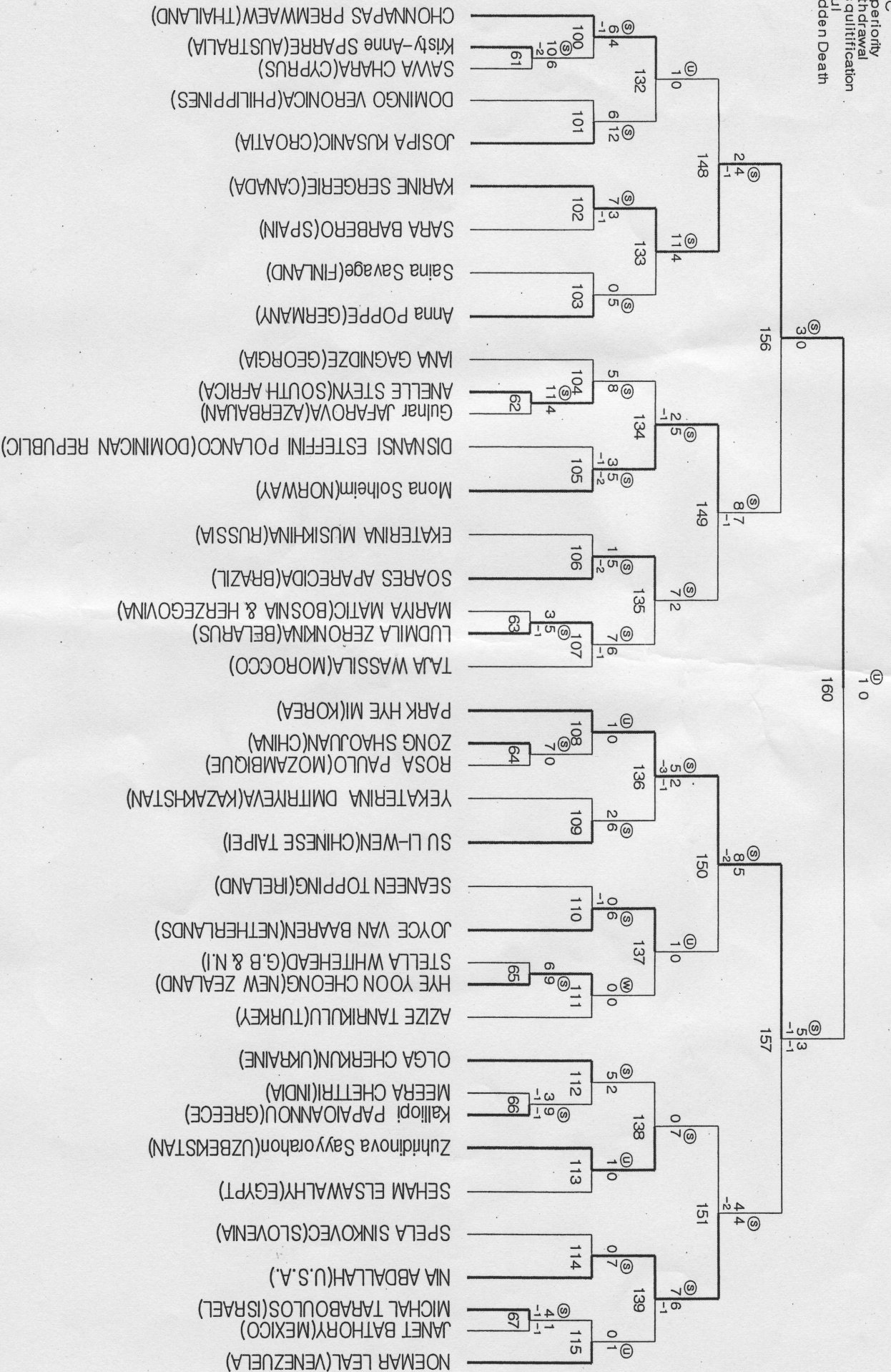

35200

Female WELTER(67KG) / 5th

4/1

- (X):K.O
- (O):RSC
- (S):Superiority
- (W):Withdrawal
- (D):Disqualification
- (F):Foul
- (U):Sudden Death

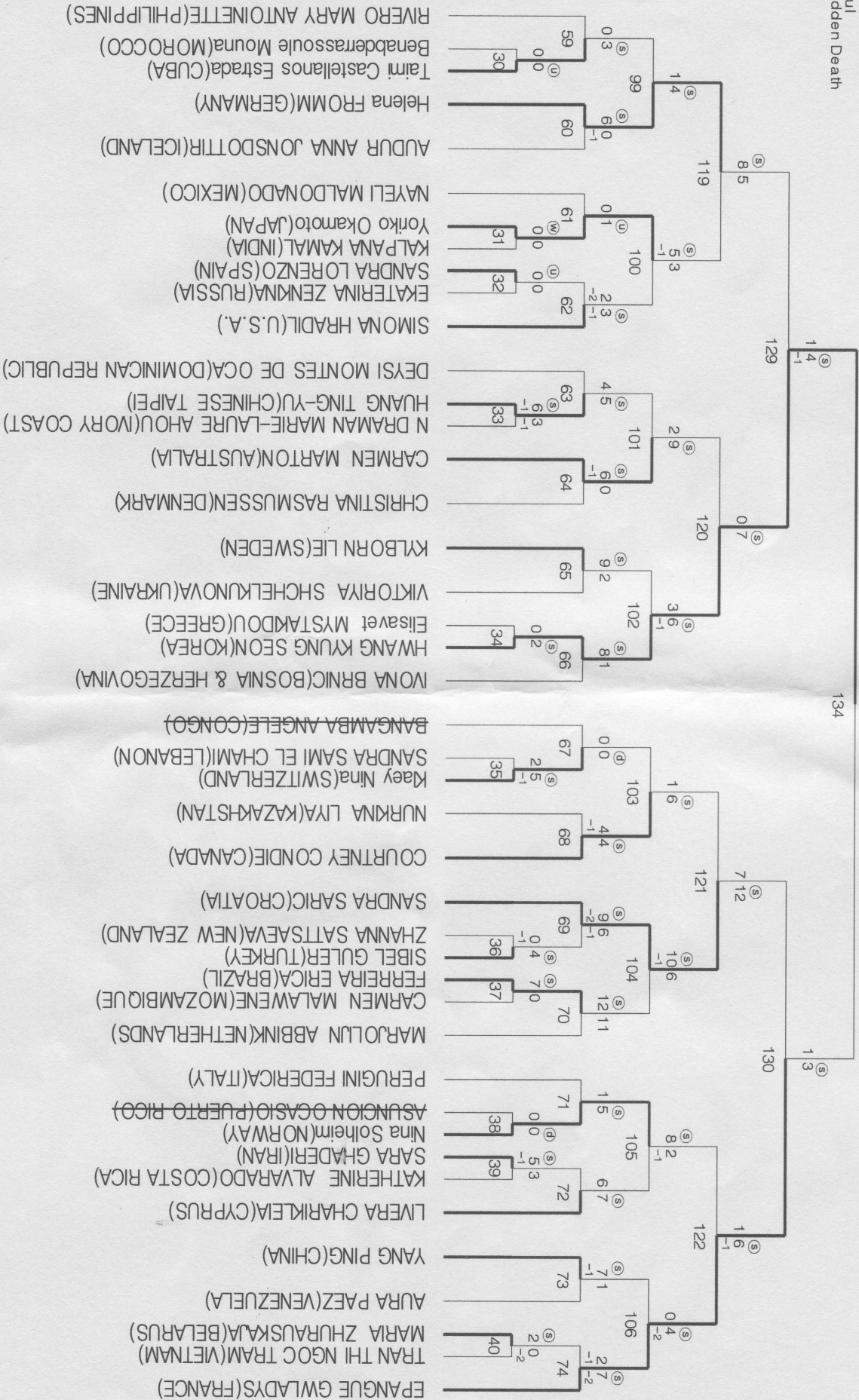

Female MIDDLE(72KG) / 3rd

- (K):KO
- (D):RSC
- (S):Superiority
- (W):Withdrawal
- (D):Disqualification
- (F):Foul
- (S):Sudden Death

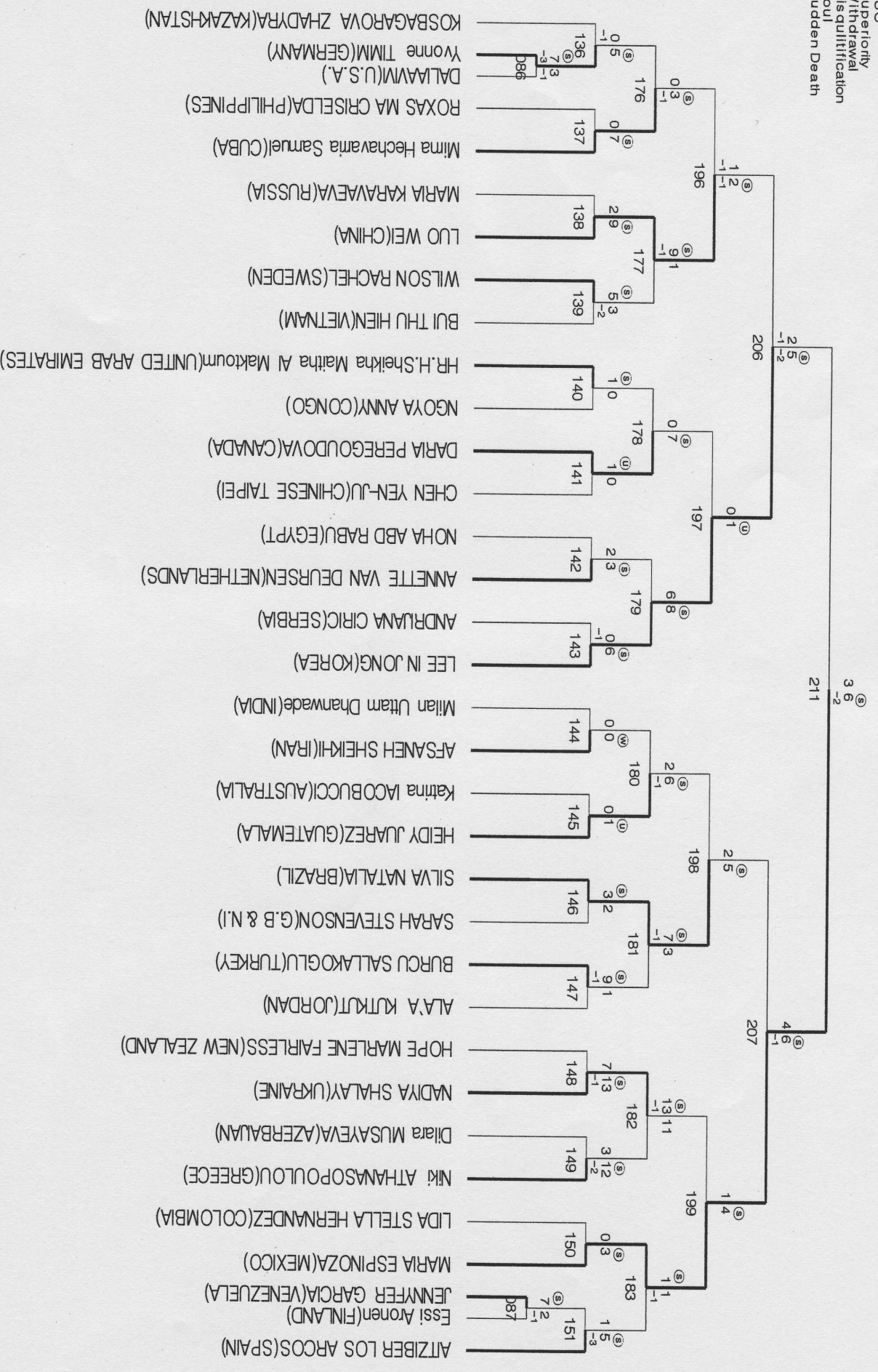

34200

Female HEAVY(+72KG) 5th

32

- Ⓚ:KO
- Ⓛ:RSC
- Ⓢ:Superiority
- Ⓦ:Withdrawal
- Ⓧ:Disqualification
- Ⓣ:Foul
- Ⓞ:Sudden Death

